

TECHNICAL DATA

Cooling capacity R404A/507 (te= -8 ⁰ C ; DT1=8K):	23,90 kW
Cooling capacity R404A/507 (te= -25 ⁰ C; DT1=7K):	18,00 kW
Exchange surface:	111,0 m ²
Tube volume:	39,2 dm ³
Air flow:	19800 m ³ /h
Air throw:	21 m
Gas coil connection:	54 Φ mm
Liquid coil connection:	15 Φ mm
Weight:	201 kg

FANS

Diameter:	500 Φ mm
Number of fans:	3
Voltage:	230/50 V/Hz
Power:	1440 W
Current:	3,6 A

ELECTRIC DEFROST

Voltage:	230/50 V/Hz
Coil block:	4x3200 W
Drip tray:	2x3200 W
Total:	19200 W

THE CORRECTION FACTORS

Tevap [°C] / DT1[K]	13	12	11	10	9	8	7	6
5	-	1,974	1,776	1,539	1,332	1,245	0,987	0,868
4	-	1,934	1,717	1,500	1,303	1,205	0,947	0,849
3	2,013	1,895	1,697	1,461	1,283	1,186	0,928	0,829
2	1,993	1,855	1,658	1,421	1,263	1,161	0,900	0,809
1	1,974	1,816	1,618	1,401	1,243	1,146	0,888	0,789
0	1,954	1,776	1,579	1,382	1,224	1,126	0,868	0,770
-5	1,737	1,618	1,461	1,303	1,164	1,085	0,849	0,750
-8	1,579	1,507	1,342	1,224	1,125	1,000	0,829	0,730
-10	1,427	1,399	1,268	1,160	1,113	0,987	0,802	0,720
-15	-	1,342	1,224	1,145	1,105	0,908	0,789	0,711
-20	-	1,224	1,145	1,066	0,947	0,868	0,770	0,691
-25	-	-	1,066	0,987	0,868	0,829	0,755	0,671
-30	-	-	-	0,908	0,789	0,770	0,691	0,651
-35	-	-	-	0,829	0,710	0,691	0,671	0,632

DIMENSIONS

A:	3492 mm
B:	644 mm
C:	730 mm
D:	3087 mm
E:	1029 mm

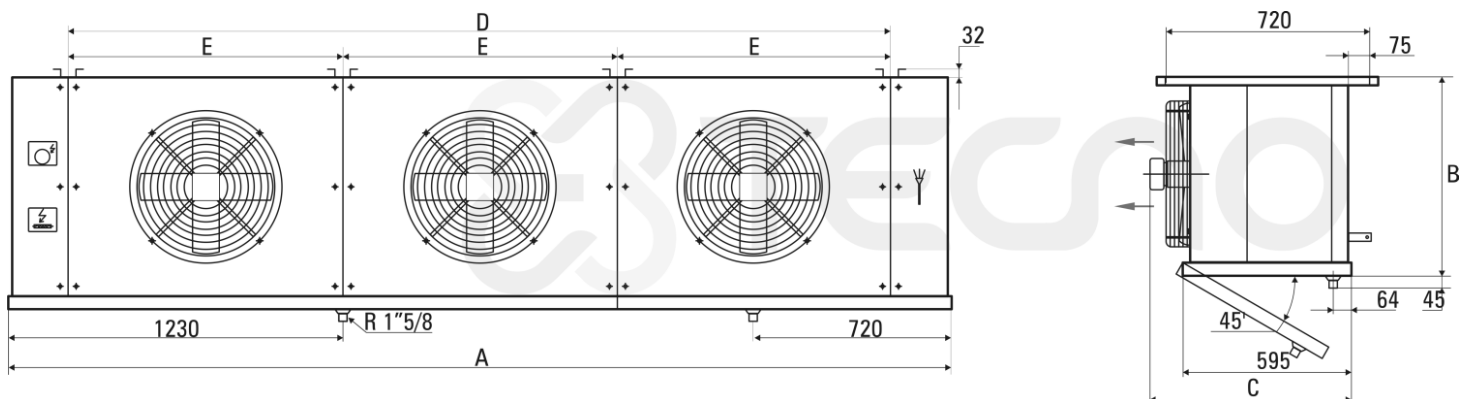

SAMPLE PICTURES

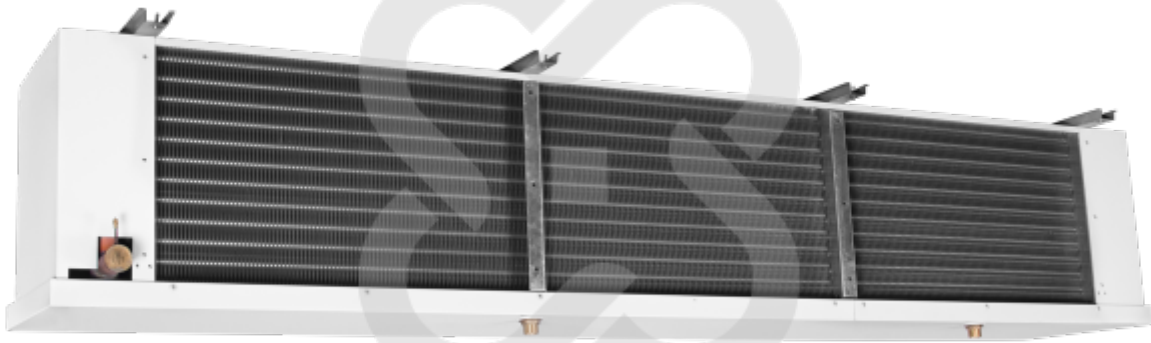
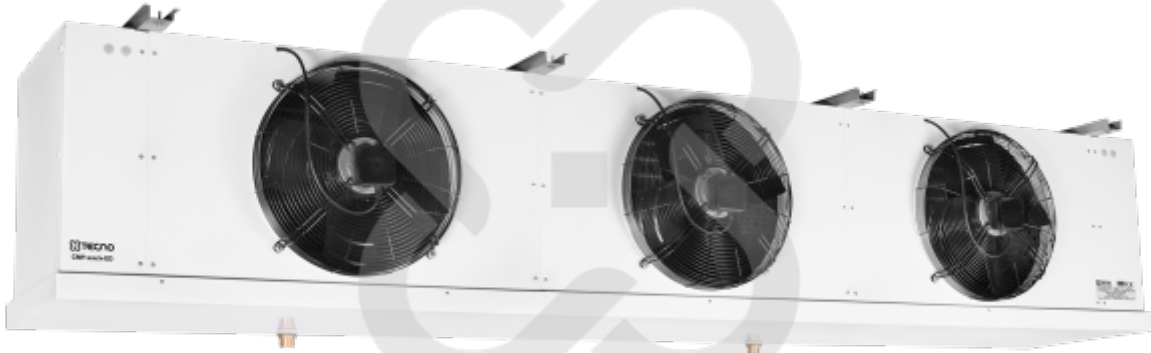

Pictures of some products may vary. Every effort was made to information contained in this catalog are correct. Due to the constant technological developments reserves the right to make changes without notice.